



## česká dřevěná podlaha czech wooden floor

pro každý den, pro každou příležitost...  
for each day, for every occasion...

**Magnum**<sup>®</sup>  
p a r k e t

M > MAGNUM – český výrobce

A > alternativní povrchové úpravy

G > garantovaná kvalita

N > Na straně přírody

U > uživatelský komfort

M > moderní trendy

M > MAGNUM – the Czech producer

A > alternative surface-treatment

G > guaranteed quality

N > nature friendly

U > users friendly

M > modern trends

## > úvod / introduction

- > Společnost MAGNUM Parket, a.s. byla založena roku 1996 za účelem vybudování závodu na výrobu vícevrstevných dřevěných parket.
  - > Výroba třívrstevných parket byla spuštěna v roce 1998.
  - > MAGNUM Parket má tradici největšího českého výrobce třívrstevných parket.
  - > Roční kapacita výrobních linek MAGNUM Parket činí 1 000 000 m<sup>2</sup>.
  - > Zpracovává přes 20 druhů dřevin a díky kombinacím povrchových úprava a třídění dřeva nabízí přes 400 dekorů dřevěných podlah.
  - > Svě stálé zákazníky má ve více než 25 zemích světa.
- 
- > MAGNUM Parket company was established in 1996 to build a factory producing multilayer wooden parquets.
  - > The production of three-layer parquets was started in 1998.
  - > MAGNUM Parket bears the tradition of the biggest Czech producer of three-layer parquets.
  - > Its annual production lines capacity is 1 000 000 sqm.
  - > Magnum processes more than 20 wood species and thanks to combination of surface treatments offers more than 400 decors of wooden parquets.
  - > MAGNUM Parket has costumers in more then 25 countries all over the world.





2

› Ice age 1-lamela › Ice age 1-strip

## > legenda / legend

Tvrdost podle Brinella  
Hardness by Brinell

3,9



1-lamela  
1-strip



2-lamela  
2-strip



3-lamela  
3-strip



Rošáda  
Rochade



Název produktu  
Product name



**Král**

uniformní výběrový vzhled, lehké tóny bez výrazných barevných kontrastů, bez barevných záběhů a běle

**King**

a highly uniform look with light colour variation and subtle grain patterns



**Střelec**

přírodní vzhled a kompromis mezi rustikálním a naturálním vzhledem, tmavší odstíny jednotlivých lamelek

**Bishop**

a natural look, compromise between rustic and uniform looks with several darker lamellas



**Country**

výrazně rustikální vzhled, velké zatmelené suky, barevné kontrasty

**Country**

strong rustic look, big putty knots, colour contrast



**Dáma**

přírodní vzhled, několik tónových odstínů, lehké barevné záběhy, a malá zdravá suková očka

**Queen**

a clean natural look with more colour variation and small, healthy knots



**Věž**

rustikální vzhled, výběr lamelek s velkými barevnými kontrasty, barevné záběhy, běl a suková očka

**Castle**

a rustic look with strong colour contrast, sapwood and knots



**Extreme**

Přírodně-rustikální vzhled, barevnostní kontrasty, suková očka, výrazné tmelené suky, přirozené vady dřeva, drobné tmelené praskliny

**Extreme**

Natural - rustical look, varied surface, small healthy knots, strong putty knots, natural wood defects, small putty cracks

## > technické informace / technical information

1. Nášlapná vrstva: tvrdé dřevo
  2. Středová vrstva: smrk
  3. Spodní vrstva: smrková dýha
- F 6 vrstev laku tvrzeného UV zářením  
– MagShield nebo přírodní olej

1. Upper layer: hardwood
  2. Middle layer: spruce
  3. Bottom layer: spruce veneer
- F 6 layers of UV hardened  
lacquer-MagShield or natural oil



### > Povrchová úprava

6 vrstev laku tvrzeného UV zářením – MagShield nebo 100% přírodní olej.

### > Surface Treatment

6 layers of UV hardened lacquer-MagShield or 100% natural oil.



## MAGShield

4

Speciálně vyvinutá ochranná vrstva nové generace, zvyšující odolnost proti poškrábání. Bílý lak, extra bílý lak, matný lak, lak s vysokým leskem.

A specially developed scratch resistant lacquer finish that can be easily re-finished. White lacquer, extra white lacquer, matt lacquer, glossy lacquer.



#### Povrchová úprava:

100% přírodní olej (přírodní, bílý, extra bílý, barevné oleje).

#### Surface treatment:

100% natural oil (natural, white oil, extra white oil, colour oils).



> **Drásaný povrch**

Rustikální vzhled zdůrazněný drásáním. Výrazná kresba a charakter dřeva.

> **Brushed surface**

A rustic look underlined by brushing technology. Distinct wood texture.



> **V-Spára**

(mikrofáze: 1x1 mm)

> **Mikrobevel**

(parameters: 1x1 mm)



> **Profesionální zámkový spoj (Välinge systém)**

> **Professional locking system (licensed by Välinge)**



> **Druhy výrobků**  
Product types



**3-lamela**  
3-strip



**2-lamela**  
2-strip



**1-lamela**  
1-strip

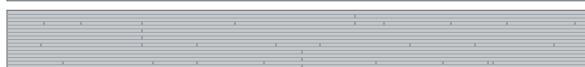

**Rošáda**  
Rochade



**Rošáda 3-lamela**  
Rochade 3-strip



> **Rozměry a balení**

15 x 205 x 2 200 mm  
1 paleta 40 balíků,  
tj. 108,4 m<sup>2</sup>  
1 balík 6 prken, tj. 2,71 m<sup>2</sup>  
1 paleta 850 kg  
1 balík 21 kg

> **Dimensions and packaging**

15x205x2 200 mm  
1 pallet 40 packages,  
i.e.108,4 m<sup>2</sup>  
1 package 6 boards, i.e. 2,71 m<sup>2</sup>  
1 pallet 850 kg  
1 package 21 kg



CE – Conformité Européenne  
(Označení shody podle harmonizované normy)  
CE – Conformité Européenne (Conformity according to harmonised standard)



Materiály používané pro výrobu třívrstevných parket MAGNUM pochází z kontrolovaných zdrojů

Materials used in the production of MAGNUM three-layer wooden parquets are from responsible sources



Ochrana před nekvalitními výrobky  
Protection against poor quality products



Poskytovaná záruka 25 let  
Warranty 25 Years



Člen Evropské federace výrobců parket  
Member of European Federation of the parquet industry



Certifikováno IBR  
IBR certified

## > Ekologie

Plnění všech nejpřísnějších ekologických norem je pro nás v MAGNUM Parket samozřejmostí a zároveň klademe ty nejvyšší požadavky na naše dodavatele. Pro výrobky MAGNUM proto využíváme výhradně bezmočovinná lepidla PVAC, 100% ekologické laky a přírodní oleje (pro povrchovou úpravu). Celý systém výroby a bezodpadové hospodářství řídíme a organizujeme tak, abychom eliminovali jakékoliv nepříznivé dopady na naše životní prostředí.

## > Ecology

MAGNUM places a priority on complying with the highest environmental standards in our industry. We also apply these same standards to our suppliers. MAGNUM products are made exclusively with formaldehyde-free PVAC, 100% ecological lacquers and natural oils (for surface treatment), and the entire production process is controlled and organised in a way which eliminates any negative impact on our environment.

## > Upozornění

Dřevo je přírodní materiál, proto vzorky nemusí přesně barevně odpovídat dodávanému materiálu. Tyto rozdíly nejsou výrobní vadou, ale charakteristickou vlastností dřeva. Po čase dochází u dřeva vlivem vnějších vlivů ke změně odstínu.

## > Warning

Wood is a natural material, that's why the samples don't exactly agree with supplied material in color. These dissimilarities are not manufacturing defect but a characteristic wood feature. After some time wood tint changes owing to external influences.





---

> kolekce / collection



Amo Dub 1-lamela, Drásaný olej Amo Oak 1-strip, Brushed oil



8

*Creative*

› Dub Amo 1-lamela Bílý olej › Oak Amo 1-strip White oil

## > creative

HAND MADE



Old style natur olej  
Old style Natur oil



Old style Rustic natur olej  
Old style Rustic Natur oil



Old style extra bílý olej  
Old style Extra White oil



Old style Rustic extra bílý olej  
Old style Rustic Extra White oil



Old style černý olej  
Old style Black oil



Old style šedý olej  
Old style Grey oil



Old style Rustic šedý olej  
Old style Rustic Grey oil



Dub AMO stříbrný  
Oak AMO Silver



Dub zlatý  
Oak Gold

> creative

HAND MADE

3,9 I



Antique  
Antique

3,9 I



Bronze Age  
Bronze Age

3,9 I



Stone Age  
Stone Age

3,9 I I



Ice Age  
Ice Age

3,9 I



Iron Age  
Iron Age

3,9 I I I



Bronze Age Rochade  
Bronze Age Rochade

3,9 I



Middle Ages  
Middle Ages

3,9 I



Dub Crack  
Oak Crack

## > creative

FREEZE

3,9



Dub Freeze bílý  
Oak Freeze White

3,9



Dub AMO Freeze bílý  
Oak AMO Freeze White

3,9



Dub Freeze bílý  
Oak Freeze White

3,9



Dub AMO Freeze bílý  
Oak AMO Freeze White

3,9





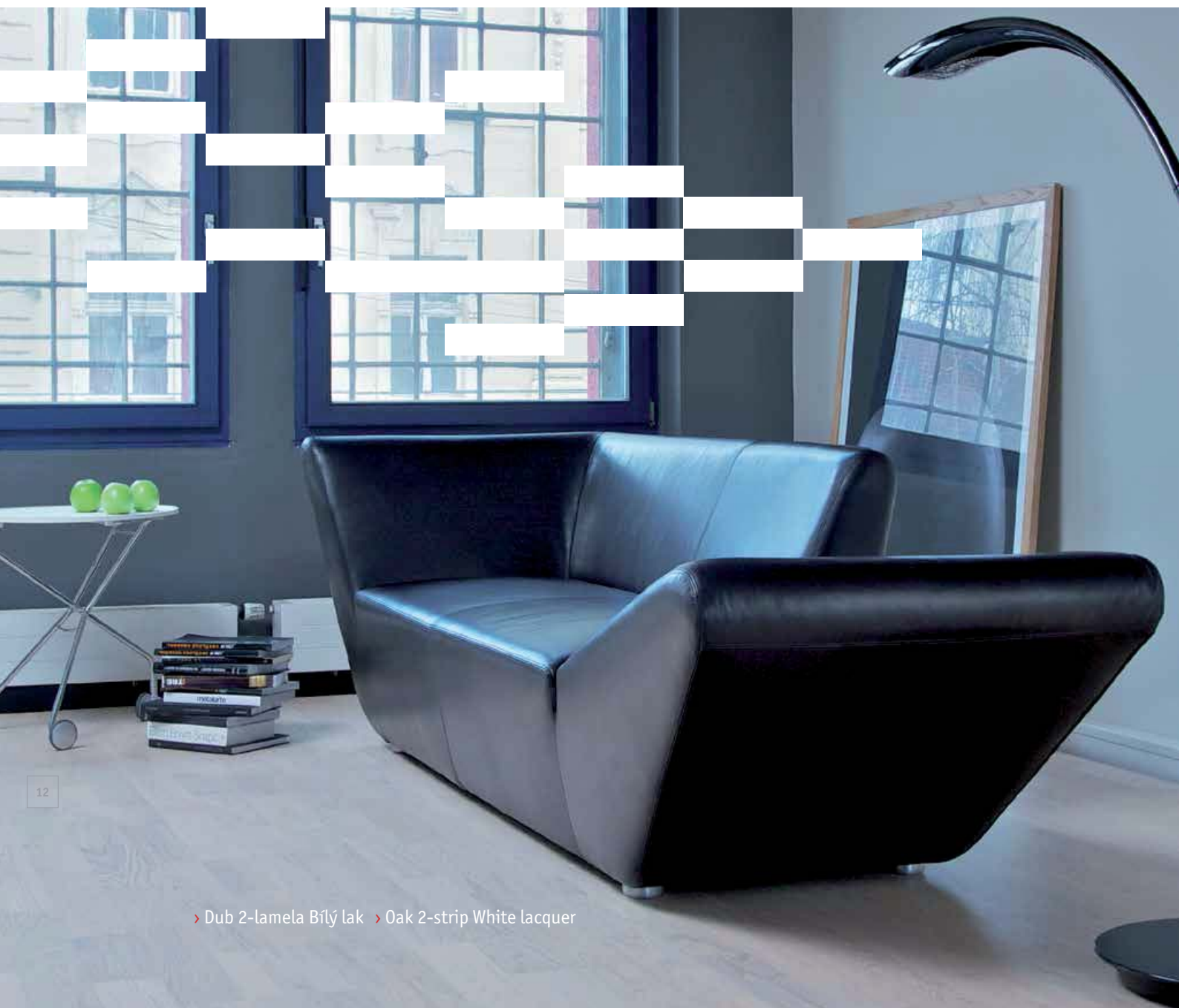





































Dub Freeze černý  
Oak Freeze Black



> creative

TRUE COLOURS

 3,9  	 3,9  	 3,9  	 3,9  
			
Dub Antik olej Oak Antik oil	Dub Black olej Oak Black oil	Dub Bordeaux olej Oak Bordeaux oil	Dub Cream olej Oak Cream oil
 3,9  	 3,9  	 3,9  	
			
Dub Extra grey olej Oak Extra grey oil	Dub Brandy olej Oak Brandy oil	Dub Ořech olej Oak Walnut oil	
 3,9  	 3,9  	 3,9  	
			
Dub Extra white olej Oak Extra white oil	Dub Honey Oak Honey	Dub Grey Oak Grey	

> creative

TRUE COLOURS

3,9



Dub Gunstock  
Oak Gunstock

3,9



Dub Mocca  
Oak Mocca

3,9



Dub Santos  
Oak Santos

3,9

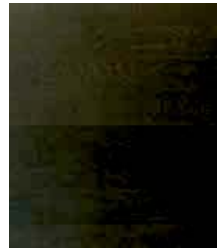

Dub Wenge  
Oak Wenge

3,9



Dub Ofech  
Oak Walnut

3,9



Jasan Mocca  
Ash Mocca

3,9



Dub Grey Rošáda  
Oak Grey Rochade

3,9



Jasan bílý lak  
Ash White lacquer

3,9



Dub extra bílý lak  
Oak Extra White lacquer

3,9



Dub bílý olej  
Oak White oil

3,9



Dub extra bílý olej  
Oak Extra White oil

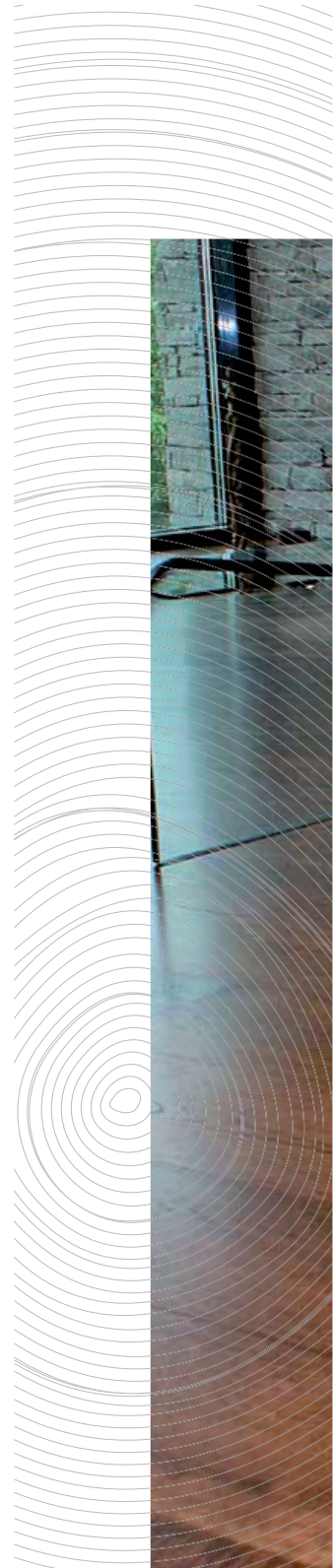



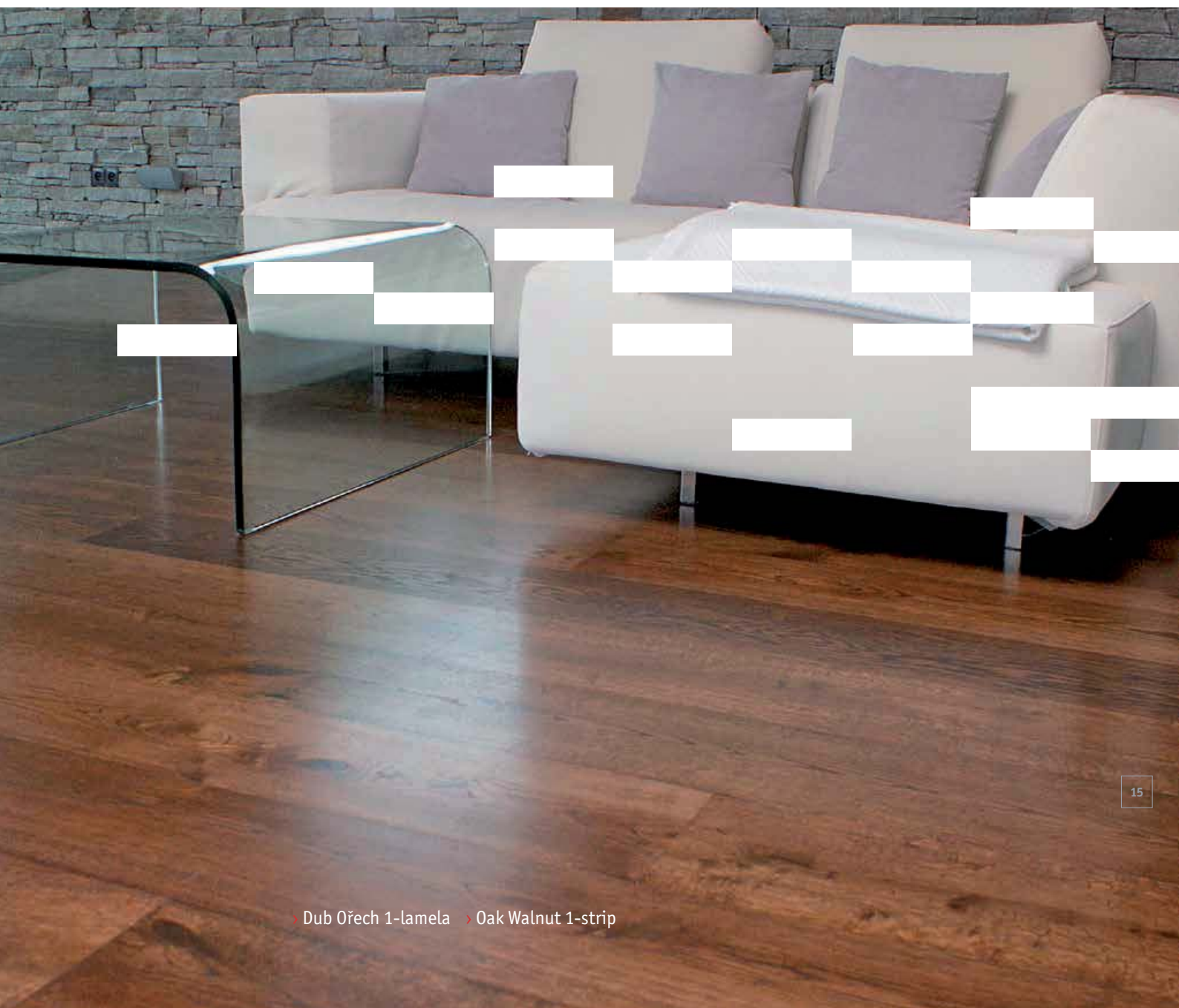

Dub Ořech 1-lamela > Oak Walnut 1-strip



## > exoty / exotics

3,5



Iroko  
Iroko

7,0



Jatoba  
Jatoba

4,9



Merbau  
Merbau

3,8



Padouk  
Padouk

4,5

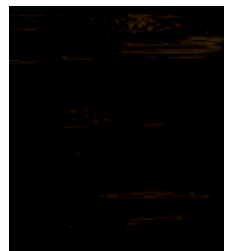

Panga-Panga  
Panga-Panga

4,0



Sapeli  
Sapeli

5,1



Zebrano  
Zebrano

4,9



Merbau  
Merbau



Zebrano Rošáda • Zebrano Rochade

## > rošády / rochade

3,9



Dub AMO  
Oak AMO

3,8



Buk pařený  
Beech steamed

3,9



Dub  
Oak

3,5



Iroko  
Iroko

4,0



Jasan  
Ash

7,0



Jatoba  
Jatoba

4,7



Javor Kanadský  
Maple Canadian

4,9



Merbau  
Merbau

3,5



Óřech  
Walnut

## > rošády / rochade

3,8



Padouk  
Padouk

4,5



Panga-Panga  
Panga-Panga

4,0



Sapeli  
Sapeli

3,6



Třešeň americká  
Cherry American

3,0



Javor Horský  
Maple European

3,9



Mix Euro  
Mix Euro

3,9



Mix Exotic  
Mix Exotic

3,5



Mix Crazy  
Mix Crazy

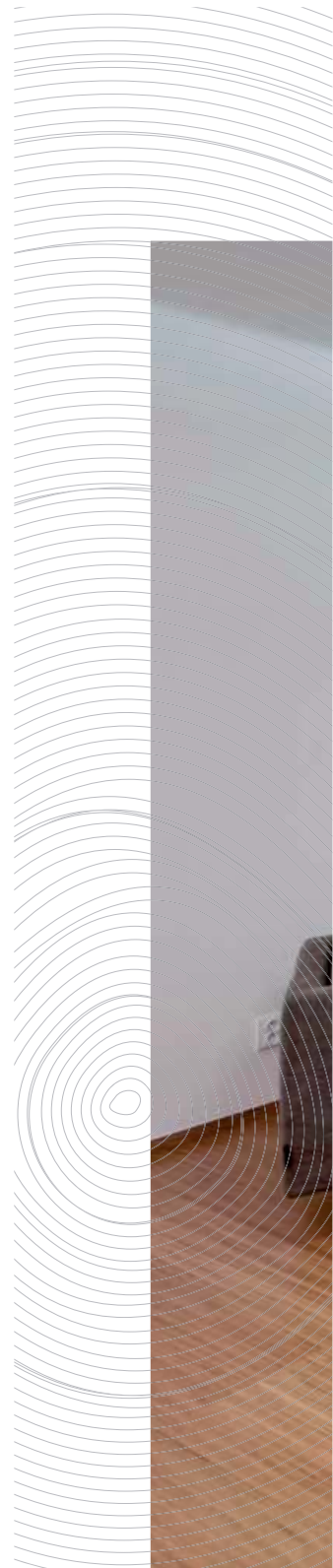



Dub rošáda > Oak Rochade





## > natur

3,8 



Buk pařený Dáma  
Beech steamed Queen

3,8 



Buk pařený Střelec  
Beech steamed Bishop

3,9 



Dub Král  
Oak King

3,9 



Dub Dáma  
Oak Queen

3,9 



Dub Střelec  
Oak Bishop

3,9 



Dub Vež  
Oak Castle

3,9 



Dub Country  
Oak Country

3,9 



Dub Pěšec  
Oak Pawn

3,9 



Dub AMO Dáma  
Oak AMO Queen

## > natur

3,9



Dub AMO Věž  
Oak AMO Castle

4,0



Jasan Král  
Ash King

4,0



Jasan Dáma  
Ash Queen

4,0



Jasan Věž  
Ash Castle

4,7



Javor kanadský Dáma  
Maple Canadian Queen

4,7



Javor kanadský Věž  
Maple Canadian Castle

3,5



Ořech Král  
Walnut King

3,5



Ořech Střelec  
Walnut Bishop

3,5



Ořech Věž  
Walnut Castle

3,6



Třešeň americká Král  
Cherry American King

## > natur

3,6



Třešeň americká Věž  
Cherry American Castle

3,2



Třešeň evropská Dáma  
Cherry European Queen

3,2



Třešeň evropská Věž  
Cherry European Castle

3,9



Dub Dáma  
Oak Queen

3,9



Dub Střelec  
Oak Bishop

3,5



Ořech Dáma  
Walnut Queen

3,5



Ořech Věž  
Walnut Castle

3,9



Dub Král  
Oak King

3,9



Dub Dáma  
Oak Queen

3,9



Dub Střelec  
Oak Bishop

## > natur

3,9



Dub Country  
Oak Country

3,9



Dub Extreme  
Oak Extreme

3,9



Dub AMO King  
Oak AMO King

3,9



Dub AMO Střelec  
Oak AMO Bishop

3,5



Dub AMO Věž  
Oak AMO Castle

3,5



Ořech Střelec  
Walnut Bishop

3,5



Ořech Country  
Walnut Country

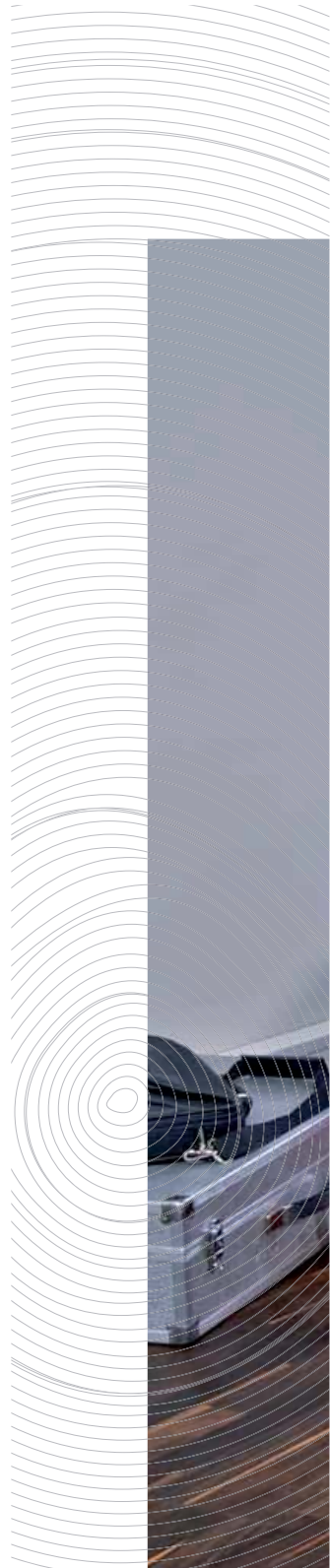



Amo Dub Věž 3-lamela › Amo Oak Castle 3-strip

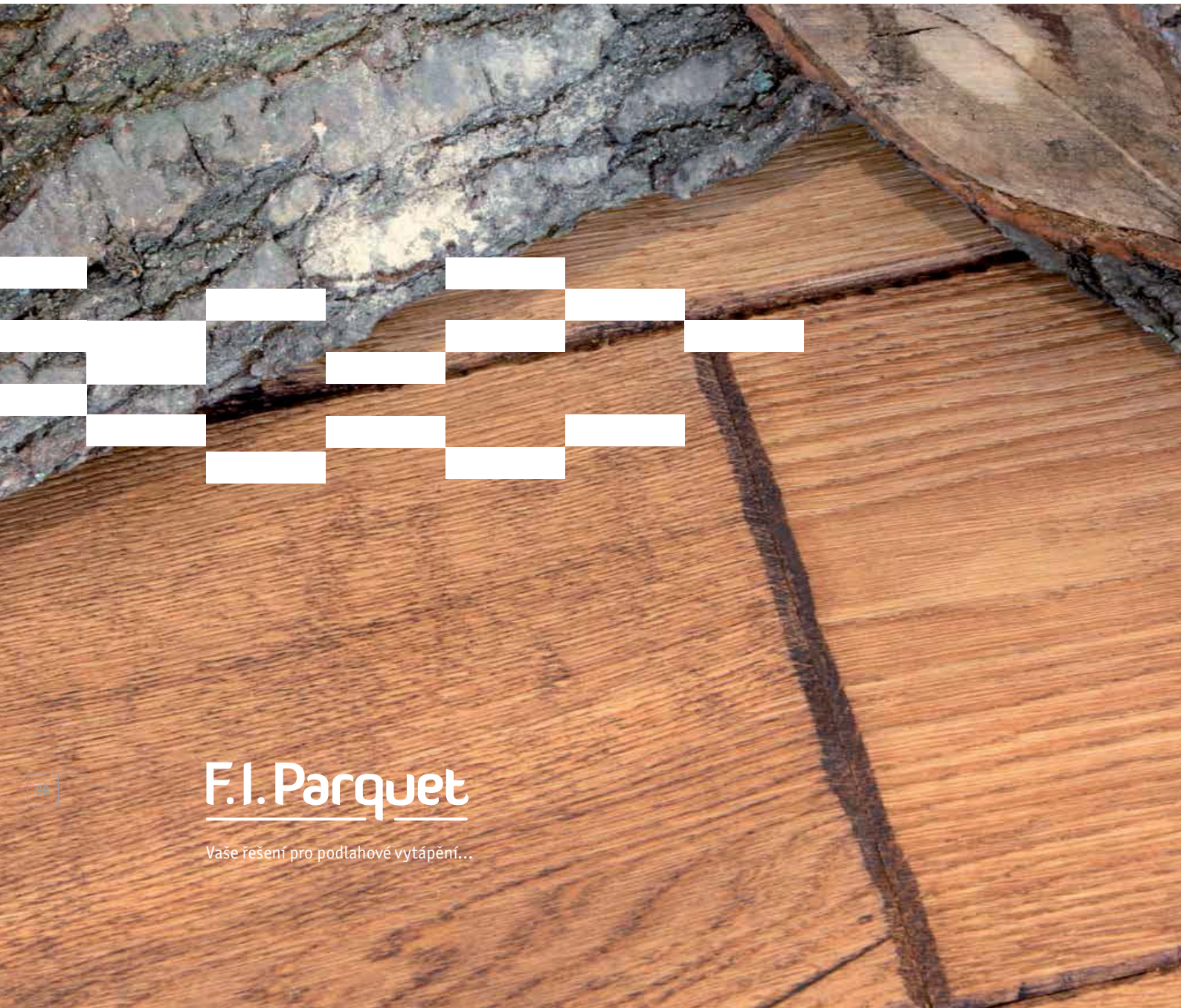

**F.I. Parquet**

Vaše řešení pro podlahové vytápění...

## > F.I.P.

Vaše řešení pro podlahové vytápění...  
Dřevěná parketa vhodná pro podlahové vytápění

### > **Magnum F.I.P (Fashion Innovated Parquet)**

Tepelný odpor F.I.P.  $R=0,096 \text{ m}^2 \text{ K/W}$ . Standardní parketová deska  $R=0,15 \text{ m}^2 \text{ K/W}$ .  
V kombinaci se střední vrstvou z OSB desky umožňuje minimalizovat teplotní ztráty vytápění a rizika rozměrové nestability podlahy.

F.I.P. – dřevěná parketa se zlepšenými užitnými vlastnostmi, která současně podporuje šetrné využívání dřevní hmoty.

- > Deska ve standardním rozměru  $2200 \times 205 \times 15 \text{ mm}$  se spojem MagLock
- > Nový vzhled, tvarová stabilita, vyšší tvrdost a odolnost
- > Rychlá pokládka, bezproblémová údržba
- > Příznivá pro životní prostředí
- > Vyrobené podle evropské normy ČSN EN 13489

### > **Dřeviny vhodné na podlahové vytápění**

Mezi vhodné (stabilní) dřeviny na podlahové vytápění patří merbau, dub, ořech.  
Nevhodné dřeviny pro pokládku na podlahové vytápění jsou buk, javor, jatoba, rošády.

Your solution for floor-heating  
First wooden parquet suitable for floor heating

### > **Magnum F.I.P (Fashion Innovated Parquet)**

Thermal resistance F.I.P.  $R=0,096 \text{ m}^2 \text{ K/W}$ . Standard wooden parquet  $R=0,15 \text{ m}^2 \text{ K/W}$ . In use with OSB middle layer the thermal loss and dimensional instability risks are minimalised.

F.I.P. – Wooden parquet with improved product qualities supporting the use of wood mass at the same time.

- > Lamella of the standard size of  $2200 \times 205 \times 15 \text{ mm}$  with MagLock joint
- > New look, stable form, higher hardness and resistance
- > Quick installation, easy maintenance
- > Environmentally friendly
- > Processed according to the european standard ČSN EN 13489

### > **Wood species suitable for floor heating**

Merbau, Oak, Walnut. Unsuitable wood species are Beech, Maple, Jatoba and Rochade.

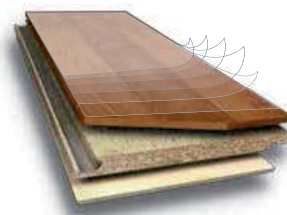

### **Složení parketové desky**

- > 6 vrstev laku tvrzených UV zářením  
- MagShield
- > nášlapná vrstva: tvrdé dřevo
- > středová vrstva: OSB - deska
- > spodní vrstva: smrková dýha

### **Floor Structure**

- > 6 layers of UV hardened lacquer-MagShield
- > Upper layer: Hardwood
- > Middle layer: OSB-board
- > Bottom layer: Spruce veneer

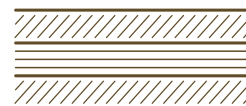

### **Detail – středová vrstva: OSB - deska**

### **Detail – Middle layer: OSB – board**





## > schodové profily / stair profiles



- > barva odpovídá podlaze MAGNUM  
Colour corresponds to the Magnum floor
- > výběr ze všech nabízených druhů dřeva  
All wooden species
- > stejný zámkový spoj – jednoduchá instalace  
Identical connection profile-easy installation
- > technicky jednotný styl  
Technically uniform style
- > vyrobeno v MAGNUM Parquet  
Produced in Magnum Parquet

- > dokonale ladící schodové profily vyrobené na míru k dřevěným třívrstvným parketám MAGNUM
- > Tailor-made stair profiles fully correspond to the structure of the three-layer Magnum wooden parquet

- > vyrobené na míru k podlahám MAGNUM
- > specially produced for Magnum floors

### Lišty / Mouldings

lišta hladká 8×40×400 mm  
smooth moulding 8×40×400 mm

lišta profilovaná 8×40×400 mm  
profiled moulding 8×40×400 mm

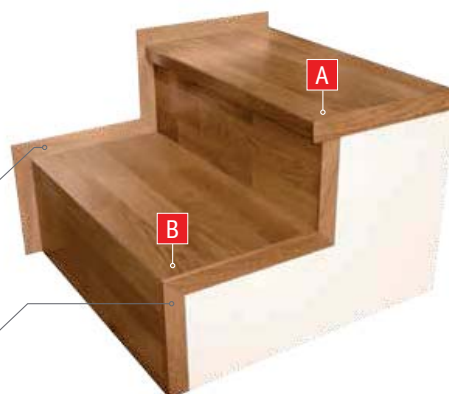

Povrchová úprava /  
Surface treatment

lak / lacquer  
olej / oil

podle povrchové úpravy  
podlahy  
according to the floor  
surface treatment

Typy / Types

**A** profil s nose  
profile with nose

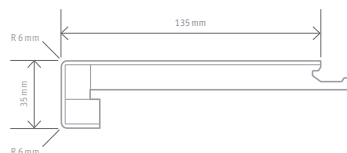

**B** profil bez nosu  
profile without nose

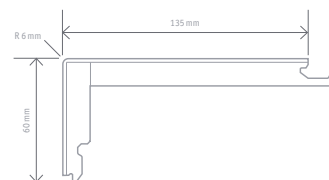



## > mosaic design

Prvky z masivního dřeva, konstrukcí i použitím podobné keramickým, příp. skleněným.  
Elements from solid timber similar to ceramic ones.

Produktovou řadu tvoří tedy kombinace druhů dřeva různých barev, od evropských klasiků po exotické extravagantní. Pružný podklad umožňuje kopírovat obkládaný povrch, takže ideální varianta pro vytvoření luxusně vyhlížejícího sloupů nebo zaoblené stěny.  
The product range is formed by wood species of various colours from European classics to the exotic extravagant ones. The bandable base enables the tiling surface copying, so, it's the ideal alternate for forming of luxuriously looking pillar or rounded wall.

### Rozměr prvku

Rozměr jednoho dílce je 29,6×29,6 cm,  
Vyrábí se ve třech rozměrech jednotlivých prvků:  
> 70×70 mm  
> 70×33,5 mm  
> 33,5×33,5 mm

### Dimension

Dimension: 29,6×29,6 cm,  
Three dimensions of individual elements:  
> 70×70 mm  
> 70×33,5 mm  
> 33,5×33,5 mm

### Třešen Americká / American Cherry



33,5×70 mm



33,5×33,5 mm

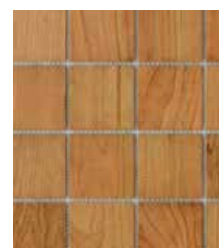

70×70 mm

### Zebrano / Zebrano



33,5×70 mm



33,5×33,5 mm

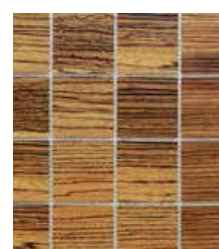

70×70 mm

## > mosaic design

### Doussie



33,5x70 mm



33,5x33,5 mm

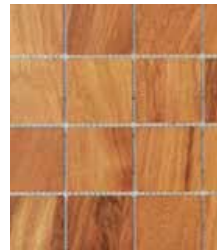

70x70 mm

### Dub / Oak



33,5x70 mm



33,5x33,5 mm



70x70 mm

### Jasan / Ash



33,5x70 mm

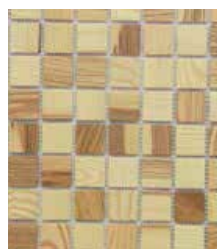

33,5x33,5 mm



70x70 mm

## > mosaic design

### Merbau

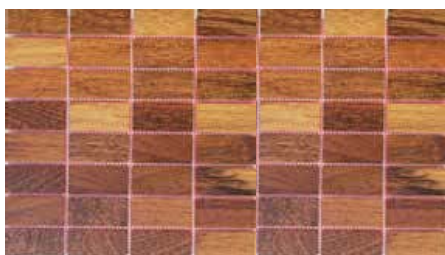

33,5×70 mm



33,5×33,5 mm

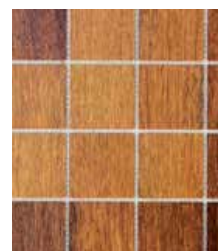

70×70 mm

### Ořech / Walnut

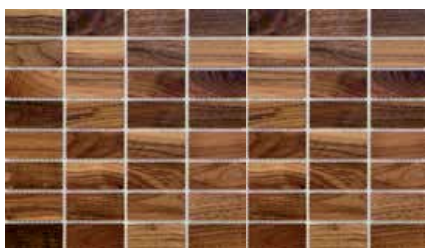

33,5×70 mm



33,5×33,5 mm



70×70 mm

### Panga-Panga

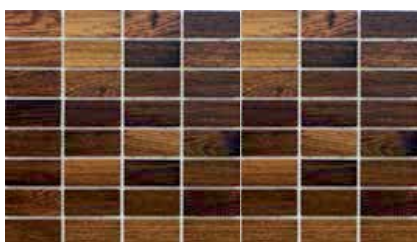

33,5×70 mm



33,5×33,5 mm



70×70 mm



## > štípaná mozaika / massive mosaic

- > rustikální vzhled  
Rustic look
- > výběr z mnoha dřevin a barevných variant  
Selection from many wood species and colour variations
- > jednoduchá instalace (jen lepení)  
Easy installation (just gluing)

### Díly z masivního dřeva, ručně štípané, lepené na plastické síťce.

rustikální vzhled, výběr z mnoha dřevin a barevných variant, jednoduchá instalace (jen lepení)

Povrchová úprava:  
olej (možnost použití barevných variant olejů)

Rozměr prvku:  
Čtverce – 285×285 mm (rozměr prvku 70×70 mm)  
Obdélníky – 280×270 mm (rozměr prvku 70×35 mm)

Dimension:  
Square – 285×285 mm (dimension of element 70×70 mm)  
Rectangle – 280×270 mm (dimension of element 70×35 mm)



### Components from solid wood manually cutted, glued on plastic net

rustic look selection from many wood species and colour variations easy installation (just gluing)

Surface treatment:  
oil (possible to use colour oils)

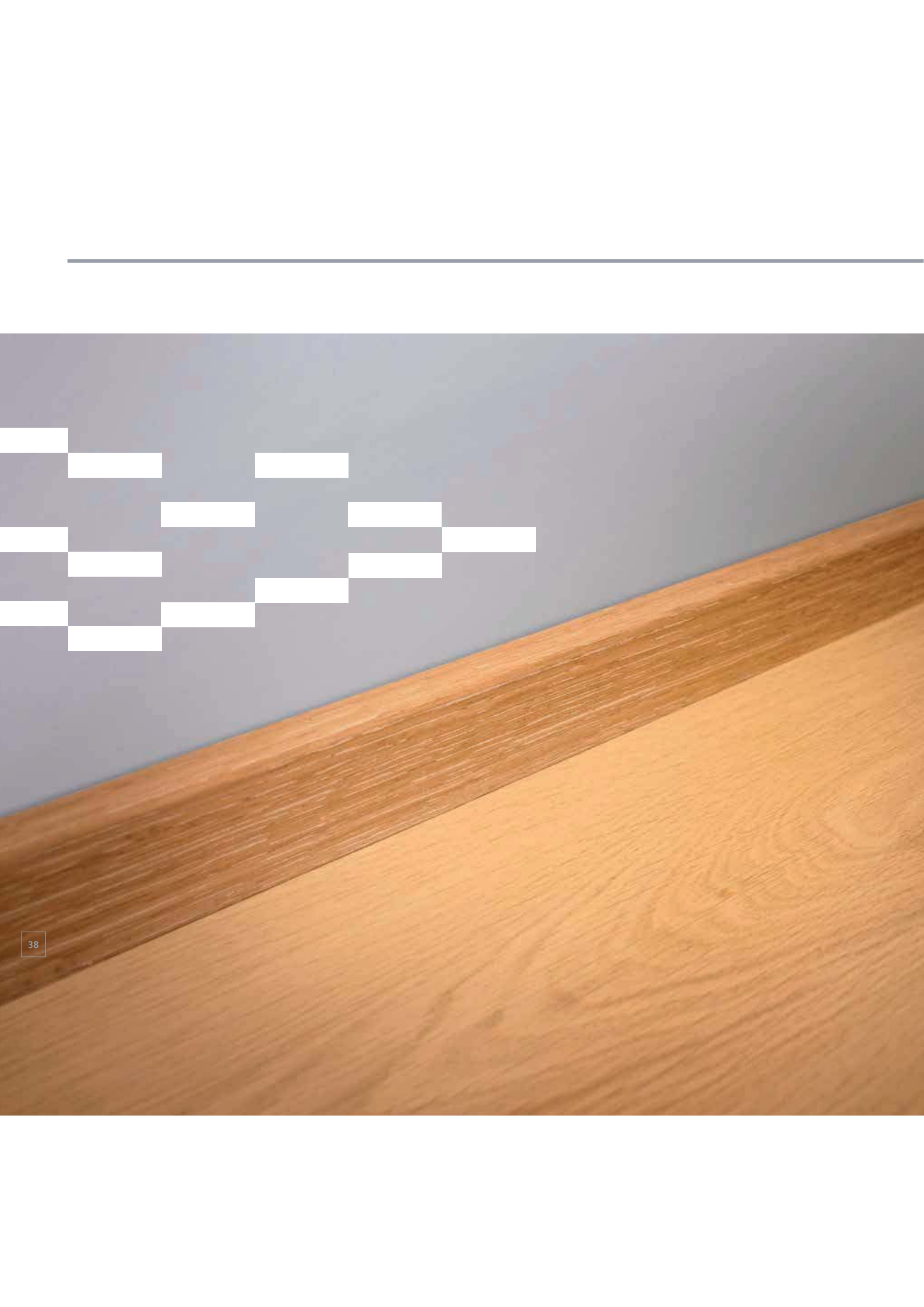



## > lišty / mouldings

### Vyrobené speciálně pro podlahy Magnum.

Určené pro speciální kolekce a produkty (Creative kolekce nebo speciální povrchové úpravy)

Rozměry:  
délka: 2 150 mm  
výška: 40–60 mm  
šířka: 18 mm

### Produced specially to MAGNUM floors

Designed for special product collections (Creative collection or special surface finish)

Dimension:  
length: 2 150 mm  
height: 40–60 mm  
width: 18 mm

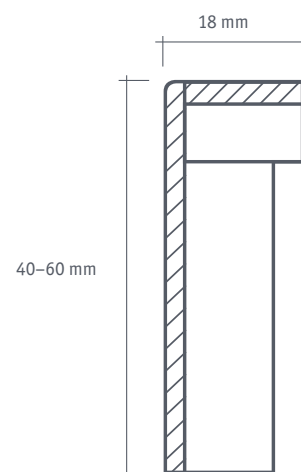

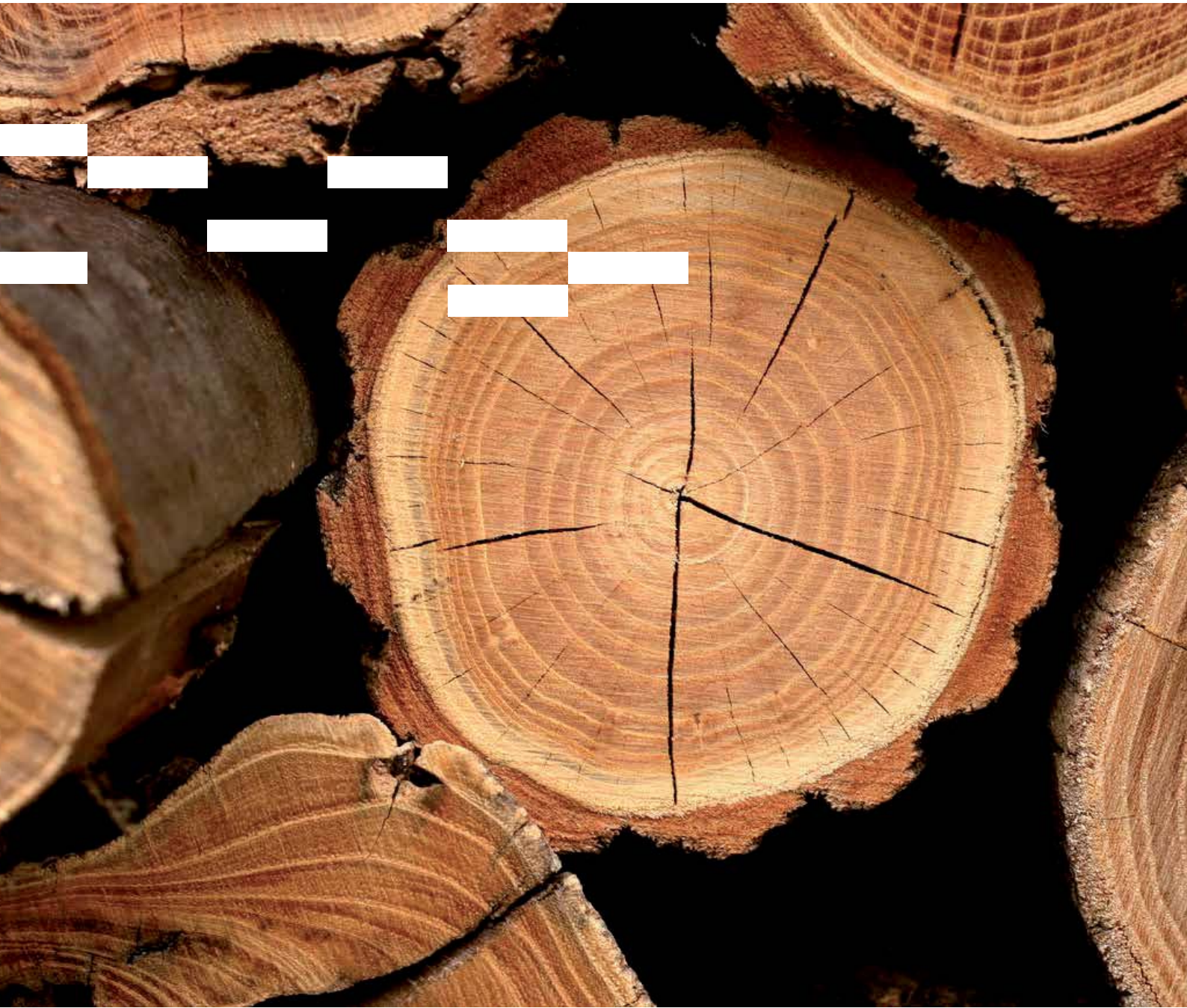

M > MAGNUM – český výrobce

A > alternativní povrchové úpravy

G > garantovaná kvalita

N > Na straně přírody

U > uživatelský komfort

M > moderní trendy

M > MAGNUM – the Czech producer

A > alternative surface-treatment

G > guaranteed quality

N > nature friendly

U > users friendly

M > modern trends

**Magnum**  
parket

váš dodavatel / your supplier

[www.magnumparket.com](http://www.magnumparket.com)

**MAGNUM Parket, a. s.**, Tovární 1,  
682 01 Vyškov, Czech Republic.  
[obchod@magnumparket.cz](mailto:obchod@magnumparket.cz), [export@magnumparket.cz](mailto:export@magnumparket.cz)

**Pobočka Praha:** V Oblouku 599,  
252 43 Praha-Průhonice, Czech Republic.  
[paha@magnumparket.cz](mailto:paha@magnumparket.cz)